

BELLA

add depth to your living space

LIGHT
IT
UP!

Company About

It all started with a passion for light. EVORINO lighting was born in 2016 with its experience and knowledge. We are working to develop luminaires of high quality and standards that direct the light with their style and aesthetics. With its structure that produces solutions for projects, we direct the products with lighting designers, architects and planners. We produce exciting products with a structure that pushes the limits of technique and design, and we bring these products together with the whole world.

We are constantly expanding our current product portfolio that can be adapted to the needs of our customers. Our knowledge, understanding of quality, experienced staff, equipment and machinery have brought us success. We have continued and continue to work with the source of satisfaction by serving each of our customers in their next projects.

Over the years Evorino has built its growth based on in-house design, R&D, quality control, testing and production. From design to engineering and prototyping, production, packaging and stocking, everything is handled at the Evorino headquarters in Turkey.

Technology & LED

We have been experiencing LED technology since its debut. It's probably the biggest advancement in lighting technology in decades. EVORINO plays a good role in applying this technology, designing and manufacturing its own LED boards, developing innovative LED products and custom solutions, enabling designers and users to make the most of previously unimagined possibilities in lighting.

The true measure of cost goes beyond just the initial purchase cost, but also includes intelligent lighting control, lifetime, maintainability and operating costs. Combining extensive product knowledge with a wide range of energy efficient product solutions and industry-specific experience, EVORINO guides you through an environmentally friendly, cost-effective and sustainable selection process without sacrificing light quality.

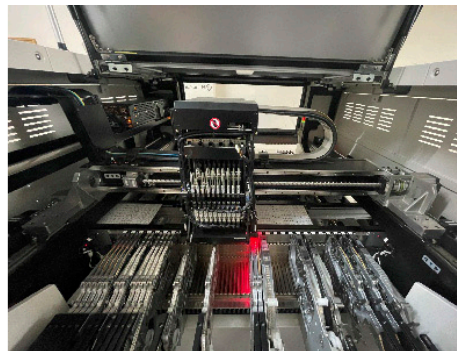

Design

Our people research and anticipate trends and develop concepts at the cutting edge of lighting technology. We work with international lighting designers, architects and planners who are constantly trying to explore boundaries and enable challenging designs. Courage and openness are the values of our Design Lab that generate groundbreaking innovations.

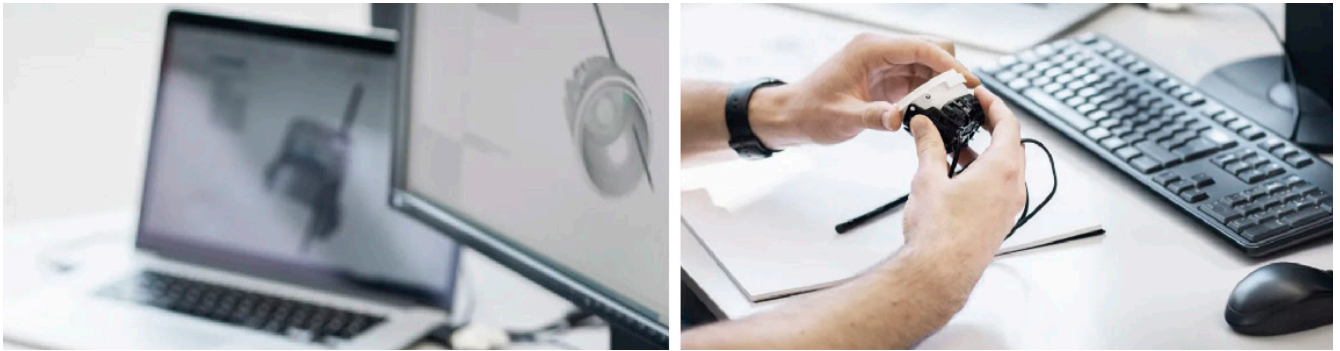

Project

Due to the enormous energy reduction, minimal heat output, low maintenance and long lifetime, LEDs are proven to provide the best return on investment. EVORINO's luminaires were developed to set standards in watts consumed per square metre, and the company's extensive manufacturing capabilities allow focus on a high price/quality ratio. EVORINO's expert team is ready to assist you in calculating ROI for your projects.



Customized Solutions

Even the most comprehensive product portfolio cannot always meet the specific requirements of a design. That's why we work with you to develop bespoke lighting solutions that are precisely tailored to the architectural and aesthetic needs of your project. Depending on the size of the project, we implement both small adaptations to existing EVORINO products and designs for completely new innovations.



Production

We are confident that the highest quality and flexibility can only be achieved with in-house expertise throughout the value chain. We produce completely in-house. From electronics manufacturing, turning, milling, laser engraving and die casting to final painting and finishing, every step is carried out in our modern production facilities. This gives us maximum quality control, even for one-off and bespoke products, and allows us to react agile to customer requirements. And we pay attention to our environment.

We are stronger with mold technology. Every day a new one is added to our molds, this allows us to design and produce extraordinary products.

Products take shape in our Injection Printing facility. Injection allows us to obtain fast and high quality finishes. This provides us with standardization and the ability to produce fast products.

The final touch of paint production, the texture of the paint is very important to us. Finishes make the texture of the products more enjoyable, we offer our customers countless combination product options by applying thousands of color alternatives to our standard products with unlimited color alternatives in our paint facility.



Quality & Warranty

We manufacture our products with care, All employees receive extensive training to guarantee the best standards of workmanship.

Throughout the entire production process, EVORINO differentiates itself by addressing the strictest quality parameters to ensure that products and services are designed and manufactured to exceed customer requirements. Every step in the manufacturing process has a routine quality procedure that covers both product quality and testing. That's why every product leaving EVORINO is thoroughly examined and tested, ensuring minimum returns and maximum efficiency.

We trust our products. Guaranteed EVORINO luminaires are manufactured to meet the highest standards. Today, tomorrow and five years from now. You can also benefit from our 5-year warranty, as we are sure of the quality of the materials we use, thanks to the production processes, sustainable technologies developed with the latest technology.

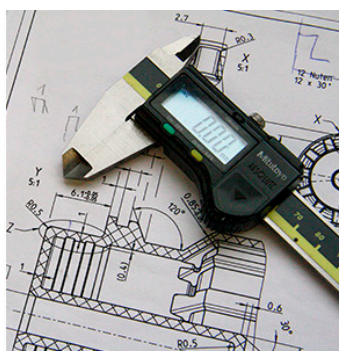
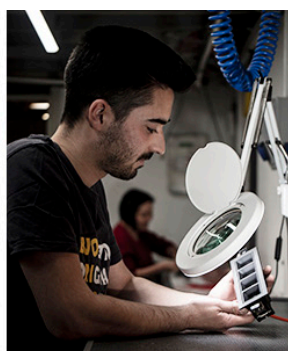

Sustainability

EVORINO invests in and continues to pursue a green-oriented philosophy for all company departments, from offices to production and warehouse. For many years, the company has devoted itself to limiting the environmental impact of its various operations as well as allocating resources, thanks to measures that support sustainable development, such as the use of renewable energies, which are almost entirely self-produced, and the reduction of consumption and CO2 emissions. recovery and recycling of production scraps and raw materials. These are just a few of the eco-friendly operations undertaken to develop a virtuous economic model. It goes without saying that all our areas in our factory are illuminated with energy-efficient LEDs.

Our production and logistics processes are constantly optimized to reduce the impact on the environment as much as possible. That's why our shipping packaging is made from recyclable material to minimize the shipping volume and amount of padding.

As a company, we see ourselves as part of a larger whole that we are connected to now and for a future worth living. Not only because our products can make a significant contribution to improving the climate balance of our customers, but also for the use of sustainable energy sources, for example, or conscious Group strategies for climate-business travel and mobility management. Social responsibility is as important to us as ecological responsibility, which is why we have identified sustainability as the core principle of our actions at all organizational levels.

We believe that the lifecycle of our actions and products should be traceable and transparent, which requires a move to clear standards. Accordingly, in addition to ISO9001,



Logistics

We are always with you. We are eager to work with lighting planners, architects and designers all over the world. International change and shared passion for light shaped the character of EVORINO. We develop, manufacture and deliver innovative luminaires to our customers worldwide.



Recessed / Spotlight



BELLA-R-I
10



BELLA-R-II
11

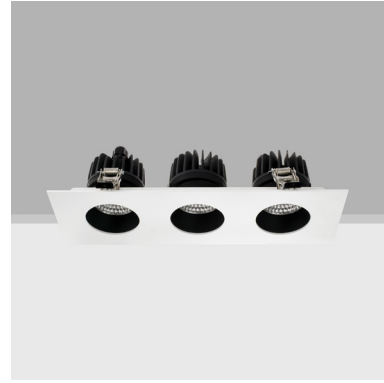

BELLA-R-III
12

Surface Mounted / Spotlight



BELLA-N-I
14



BELLA-N-II
15

BELLA-R-I

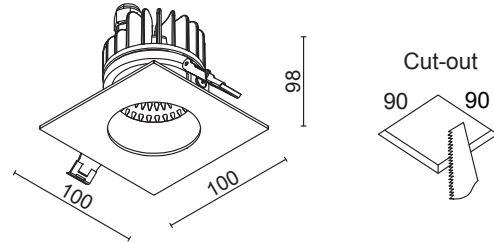

Product Family Code
E1.2.3.1.0144



Product Features

Mounting Location	Ceiling
Mounting Type	Recessed
Light Source	COB LED
Optic	Reflector
Body Material	Aluminum
Body Paint	Acrylic
IP Rating	IP44
Origin	Turkey
Warranty	Up to 5 Years

Electrical Data

Operating Voltage	220V - 240V AC
Operating Frequency	50 Hz / 60 Hz
Electrical Protection Class	II
Driver (Excluded)	Osram
Led	Samsung
Dimming	Optional (Depends On Driver)

Performance Data

Operating Temperature (ta)	-20°C to +45°C
Storage Temperature	-30°C to +60°C
Colour rendering index (CRI)	Ra>80 / Ra>90
Rated life (L70)	60 000 h
System Efficiency (lm/W)	Up to 115

Light Output

Adjustability	Fixed
Light Distribution	Direct

Dimension

Width	100 mm
Length	100 mm
Height	98mm
Cut-Out	90 mm x 90 mm
Min. Recessed Depth	98 mm

A LIGHT SOURCE	B DIMENSIONS	C LIGHT COLOR	D POWER	E CONTROL	F BODY COLOR	G BODY FINISH	H OPTIC	I EMERGENCY KIT
1 LED	1 A:100 mm X B:100 mm X H:98 mm	1 2700K Ra>80 2 3000K Ra>80 3 4000K Ra>80 4 6500K Ra>80 5 2700K Ra>90 6 3000K Ra>90 7 4000K Ra>90 8 6500K Ra>90 13 T.WHITE	6 6 Watt 8 8 Watt 10 10 Watt 12 12 Watt 14 14 Watt 14 20 Watt	1 ON-OFF 2 DALI 3 PHASE-CUT	1 RAL9003 2 RAL9016 3 RAL9010 4 RAL9006 5 RAL7011 6 RAL7016 7 RAL7021 8 RAL9004 9 RAL9005 99 OTHER	1 Matt 2 Texture	24 24° 36 36° 60 60°	1 1 Hours 3 3 Hours 9 W/O KIT

BELLA-R-II

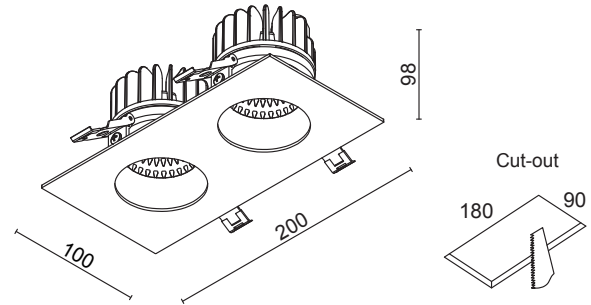

Product Family Code
E1.2.3.1.0145

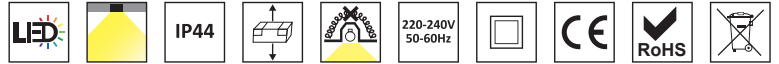

Product Features

Mounting Location	Ceiling
Mounting Type	Recessed
Light Source	COB LED
Optic	Reflector
Body Material	Aluminum
Body Paint	Acrylic
IP Rating	IP44
Origin	Turkey
Warranty	Up to 5 Years

Electrical Data

Operating Voltage	220V - 240V AC
Operating Frequency	50 Hz / 60 Hz
Electrical Protection Class	II
Driver (Excluded)	Osram
Led	Samsung
Dimming	Optional (Depends On Driver)

Performance Data

Operating Temperature (ta)	-20°C to +45°C
Storage Temperature	-30°C to +60°C
Colour rendering index (CRI)	Ra>80 / Ra>90
Rated life (L70)	60 000 h
System Efficiency (lm/W)	Up to 115

Light Output

Adjustability	Fixed
Light Distribution	Direct

Dimension

Width	100 mm
Length	200mm
Height	98mm
Cut-Out	90 mm x 180 mm
Min. Recessed Depth	98 mm

A LIGHT SOURCE	B DIMENSIONS	C LIGHT COLOR	D POWER	E CONTROL	F BODY COLOR	G BODY FINISH	H OPTIC	I EMERGENCY KIT
1 LED	1 A:100 mm X B:200 mm X H:98 mm	1 2700K Ra>80 2 3000K Ra>80 3 4000K Ra>80 4 6500K Ra>80 5 2700K Ra>90 6 3000K Ra>90 7 4000K Ra>90 8 6500K Ra>90 13 T.WHITE	2006 2x6 Watt 2008 2x8 Watt 2010 2x10 Watt 2012 2x12 Watt 2014 2x14 Watt 2020 2x20 Watt	1 ON-OFF 2 DALI 3 PHASE-CUT	1 RAL9003 2 RAL9016 3 RAL9010 4 RAL9006 5 RAL7011 6 RAL7016 7 RAL7021 8 RAL9004 9 RAL9005 99 OTHER	1 Matt 2 Texture	24 24° 36 36° 60 60°	1 1 Hours 3 3 Hours 9 W/O KIT

BELLA-R-III

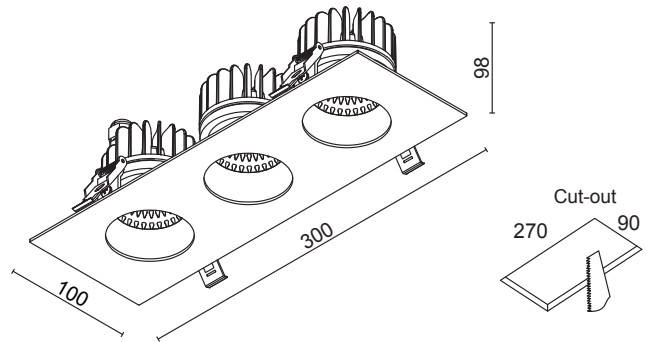
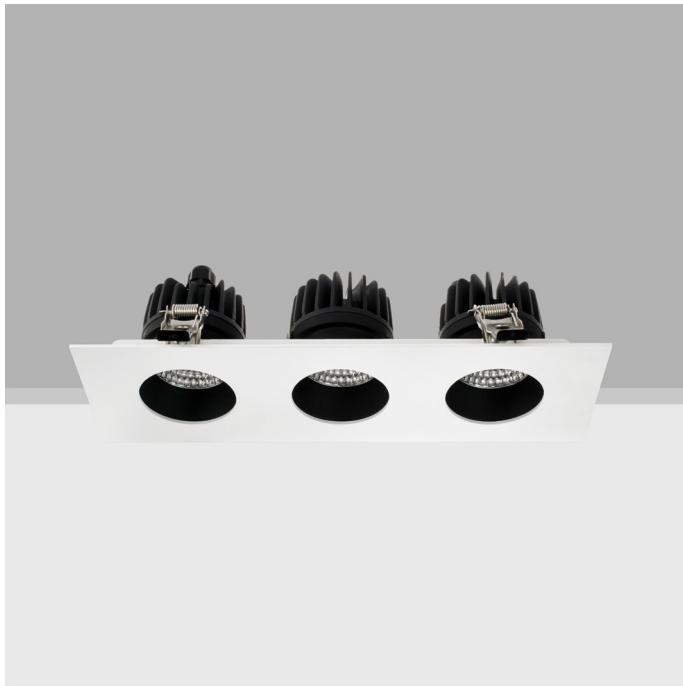

Product Family Code
E1.2.3.1.0146



Product Features

Mounting Location	Ceiling
Mounting Type	Recessed
Light Source	COB LED
Optic	Reflector
Body Material	Aluminum
Body Paint	Acrylic
IP Rating	IP44
Origin	Turkey
Warranty	Up to 5 Years

Light Output

Adjustability	Fixed
Light Distribution	Direct

Dimension

Width	100 mm
Length	300 mm
Height	98mm
Cut-Out	90 mm x 270 mm
Min. Recessed Depth	98 mm

Electrical Data

Operating Voltage	220V - 240V AC
Operating Frequency	50 Hz / 60 Hz
Electrical Protection Class	II
Driver (Excluded)	Osram
Led	Samsung
Dimming	Optional (Depends On Driver)

Performance Data

Operating Temperature (ta)	-20°C to +45°C
Storage Temperature	-30°C to +60°C
Colour rendering index (CRI)	Ra>80 / Ra>90
Rated life (L70)	60 000 h
System Efficiency (lm/W)	Up to 115

A LIGHT SOURCE	B DIMENSIONS	C LIGHT COLOR	D POWER	E CONTROL	F BODY COLOR	G BODY FINISH	H OPTIC	I EMERGENCY KIT
1 LED	1 A:100 mm X B:300 mm X H:98 mm	1 2700K Ra>80 2 3000K Ra>80 3 4000K Ra>80 4 6500K Ra>80 5 2700K Ra>90 6 3000K Ra>90 7 4000K Ra>90 8 6500K Ra>90 13 T.WHITE	3006 3x6 Watt 3008 3x8 Watt 3010 3x10 Watt 3012 3x12 Watt 3014 3x14 Watt	1 ON-OFF 2 DALI 3 PHASE-CUT	1 RAL9003 2 RAL9016 3 RAL9010 4 RAL9006 5 RAL7011 6 RAL7016 7 RAL7021 8 RAL9004 9 RAL9005 99 OTHER	1 Matt 2 Texture	24 24° 36 36° 60 60°	1 1 Hours 3 3 Hours 9 W/O KIT



BELLA-N-I

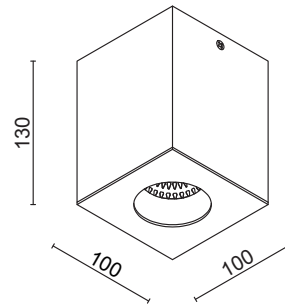

Product Family Code
E1.1.3.1.0147



Product Features

Mounting Location	Ceiling
Mounting Type	Surface Mounted
Light Source	COB LED
Optic	Reflector
Body Material	Aluminum
Body Paint	Acrylic
IP Rating	IP20
Origin	Turkey
Warranty	Up to 5 Years

Electrical Data

Operating Voltage	220V - 240V AC
Operating Frequency	50 Hz / 60 Hz
Electrical Protection Class	I
Driver (Included)	Osram
Led	Samsung
Dimming	Optional (Depends On Driver)

Light Output

Adjustability	Fixed
Light Distribution	Direct

Performance Data

Operating Temperature (ta)	-20°C to +45°C
Storage Temperature	-30°C to +60°C
Colour rendering index (CRI)	Ra>80 / Ra>90
Rated life (L70)	60 000 h
System Efficiency (lm/W)	Up to 115
UGR Rate	<19

Dimension

Width	100 mm
Length	100 mm
Height	130mm

A LIGHT SOURCE	B DIMENSIONS	C LIGHT COLOR	D POWER	E CONTROL	F BODY COLOR	G BODY FINISH	H OPTIC	I EMERGENCY KIT
1 LED	1 A:100 mm X B:100 mm X H:130 mm	1 2700K Ra>80 2 3000K Ra>80 3 4000K Ra>80 4 6500K Ra>80 5 2700K Ra>90 6 3000K Ra>90 7 4000K Ra>90 8 6500K Ra>90	6 6 Watt 8 8 Watt 10 10 Watt 12 12 Watt 14 14 Watt 20 20 Watt	1 ON-OFF 2 DALI 3 PHASE-CUT	1 RAL9003 2 RAL9016 3 RAL9010 4 RAL9006 5 RAL7011 6 RAL7016 7 RAL7021 8 RAL9004 9 RAL9005 99 OTHER	1 Matt 2 Texture	24 24° 36 36° 60 60°	9 W/O KIT

BELLA-N-II

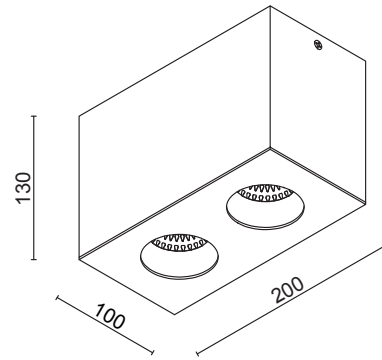

Product Family Code
E1.1.3.1.0148



Product Features

Mounting Location	Ceiling
Mounting Type	Surface Mounted
Light Source	COB LED
Optic	Reflector
Body Material	Aluminum
Body Paint	Acrylic
IP Rating	IP20
Origin	Turkey
Warranty	Up to 5 Years

Electrical Data

Operating Voltage	220V - 240V AC
Operating Frequency	50 Hz / 60 Hz
Electrical Protection Class	I
Driver (Included)	Osram
Led	Samsung
Dimming	Optional (Depends On Driver)

Light Output

Adjustability	Fixed
Light Distribution	Direct

Performance Data











































Operating Temperature (ta)	-20°C to +45°C
Storage Temperature	-30°C to +60°C
Colour rendering index (CRI)	Ra>80 / Ra>90
Rated life (L70)	60 000 h
System Efficiency (lm/W)	Up to 115
UGR Rate	<19

Dimension

Width	100 mm
Length	200 mm
Height	130mm

A LIGHT SOURCE	B DIMENSIONS	C LIGHT COLOR	D POWER	E CONTROL	F BODY COLOR	G BODY FINISH	H OPTIC	I EMERGENCY KIT
1 LED	1 A:100 mm X B:200 mm X H:130 mm	1 2700K Ra>80 2 3000K Ra>80 3 4000K Ra>80 4 6500K Ra>80 5 2700K Ra>90 6 3000K Ra>90 7 4000K Ra>90 8 6500K Ra>90	2006 2x6 Watt 2007 2x7 Watt 2010 2x10 Watt 2012 2x12 Watt 2014 2x14 Watt	1 ON-OFF 2 DALI 3 PHASE-CUT	1 RAL9003 2 RAL9016 3 RAL9010 4 RAL9006 5 RAL7011 6 RAL7016 7 RAL7021 8 RAL9004 9 RAL9005 99 OTHER	1 Matt 2 Texture	24 24° 36 36° 60 60°	1 1 Hours 3 3 Hours 9 W/O KIT

how to read symbols & suffixes

	Led Light		Protection class III, Safety Extra-Low Voltage (SELV)
	Ceiling - Recessed Mounting		Motion sensor
	Ceiling - Suspended Mounting		The luminaire can be rotated around the value of the number
	Ceiling - Surface Mounting		The luminaire is around the value of the number uniaxial tiltable
	Wall - Wall Surface Mounted		The luminaire is around the value of the number uniaxial tiltable
	Wall - Wall Recessed Mounting		The luminaire is cardan tiltable around the value of the number
	Floor - Free Standing		The light is one-sided around the value of the number tiltable
	Floor - Fixed Standing		Fixed
	Floor - Surface Mounting		Mains voltage and frequency
	Floor - Recessed Mounting		Operating Voltage
	Ceiling - Cell Ceiling		Installation without tools
	Ceiling - Semi Recessed		Energy efficiency
	Ceiling - Direct and Indirect		Product with TSE mark
	Ceiling - Track Mounted		VDE certified (Association of German Elect. Engineers)
	Ceiling - Baffle Ceiling		CE certified
	Degree of protection against solid bodies and penetration by liquids		Product with ENEC mark
	Protection classes (Back) Protection classes (Front)		Product with RoHS mark
	Driver excluded		Disposing of luminaires
	Driver included		
	Led luminaire must not be covered by any materials		
	Level of shock resistance		
	Square wall or ceiling cut-out		
	Round wall or ceiling cut-out		
	Protection class I, protection insulation		
	Protection class II, protection insulation		

Protection Classes

IPXY

1st (x) digit: foreign body protection

IP 1X protection against penetration of foreign bodies \geq 50mm
IP 2X protection against penetration of foreign bodies \geq 12mm
IP 3X protection against penetration of foreign bodies \geq 2.5mm
IP 4X protection against penetration of foreign bodies \geq 1mm
IP 5X protection against harmful dust deposit
IP 6X protection against dust entry

2st (y) digit: water protection

IP 1X protection against drops water falling vertically
IP 2X protection against drops water from angles up to 15°
IP 3X protection against showers up to 60°
IP 4X protection against splash water
IP 5X protection against temporary immersion
IP 6X protection against permanent submersion

IKxx

Resistance to external mechanical impacts: IK code refers to the maximum external impact the luminaire is capable to withstand, without irreversible damage. In compliance with EN50102 standards. recessed wall and ceiling installation, suspended fitting.

IK code	Impact Energy	Mass/Height
IK00	0,00 Joule	-
IK01	0,15 Joule	0,2Kg/70mm
IK02	0,20 Joule	0,2Kg/100mm
IK03	0,35 Joule	0,2Kg/175mm
IK04	0,50 Joule	0,2Kg/250mm
IK05	0,70 Joule	0,2Kg/250mm
IK06	1,00 Joule	0,5Kg/200mm
IK07	2,00 Joule	0,5Kg/400mm
IK08	5,00 Joule	1,7Kg/295mm
IK09	10,00 Joule	5,0Kg/200mm
IK10	20,00 Joule	5,0Kg/400mm

Mounting Type

-R	Recessed
-N	Surface Mounted
-S	Suspended
-SR	Semi Recessed
-T	Track mounted
-W	Wall Mounted
-WR	Wall Recessed
-C	Cell Ceiling
-B	Buffle Ceiling
-AS	Asymmetric
-TR	Trimless

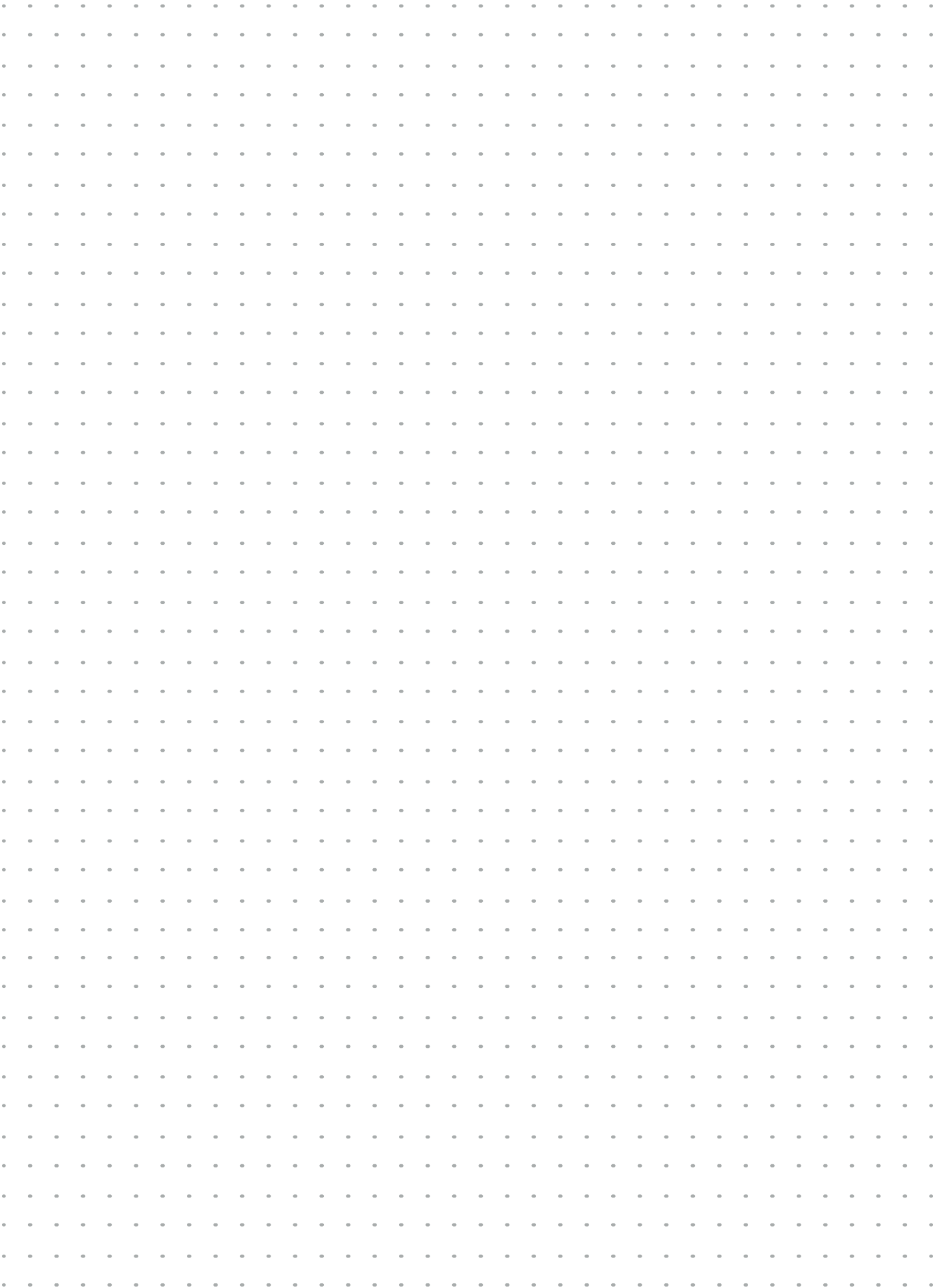

Evorino

evorino.com